

NOTES:

1. PLASTIC MATERIAL - ABS UL94V-O.
2. INCH [mm] DIMENSIONS (REFERENCE)

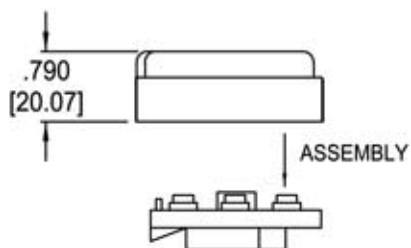

AT42A4
4 POS
CONNECTOR
BLOCK

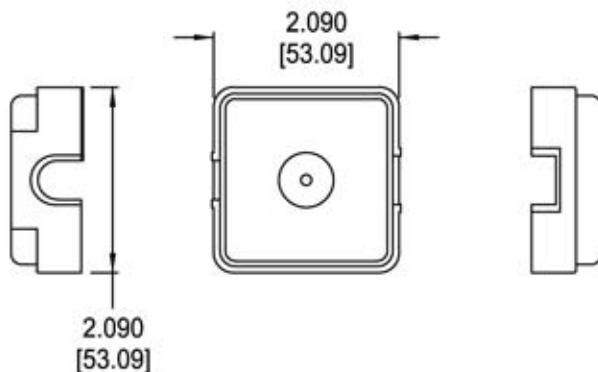
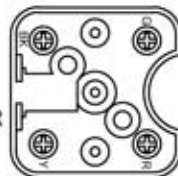

Allen Tel Products, Inc.

30 TV5 DRIVE • HENDERSON, NV • 89014



AT42A4
SURFACE JACK